

ITEM NO.	P/N	DESCRIPTION	QTY.
1	BPDT	BACKPLATE	2
2	NKSL-58	Support	2
3	NKSL-1.25	END CAP	2
4	BL2T-1	BALL HUB	2
5	BLDT1T-34	END BALL	2
6	IRWRT-22	WOOD SHELF	1

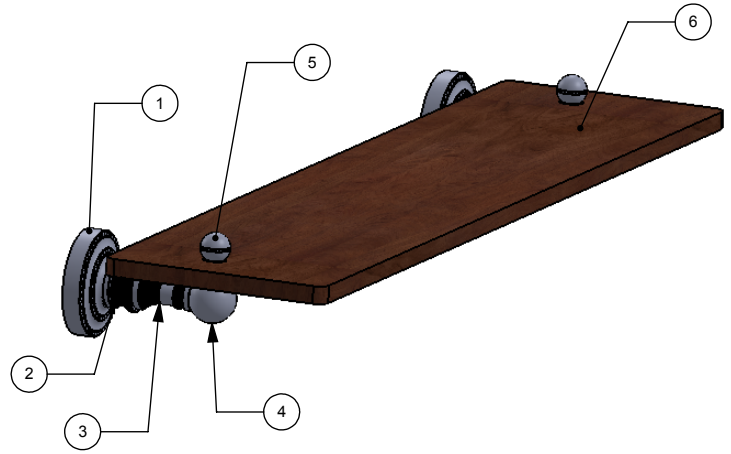

UNLESS OTHERWISE STATED

.X	±.3mm
.XX	±.15mm
.XXX	±.008mm

COPYRIGHT © Allied Brass 2016

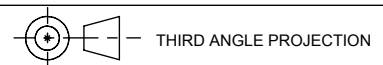

DRAWN	12/4/2016	I.M
CHECKED	12/4/2016	P.D
APPROVED	12/4/2016	R.A

MATERIAL:	BRASS		FINISH	TBD
DESCRIPTION:	GLASS SHELF		QUANTITY	TBD
		DRAWING No.		REV
		DT-1-22-IRW		0
SCALE	1:3.5	SHEET: 01	A4	