

WS-69009

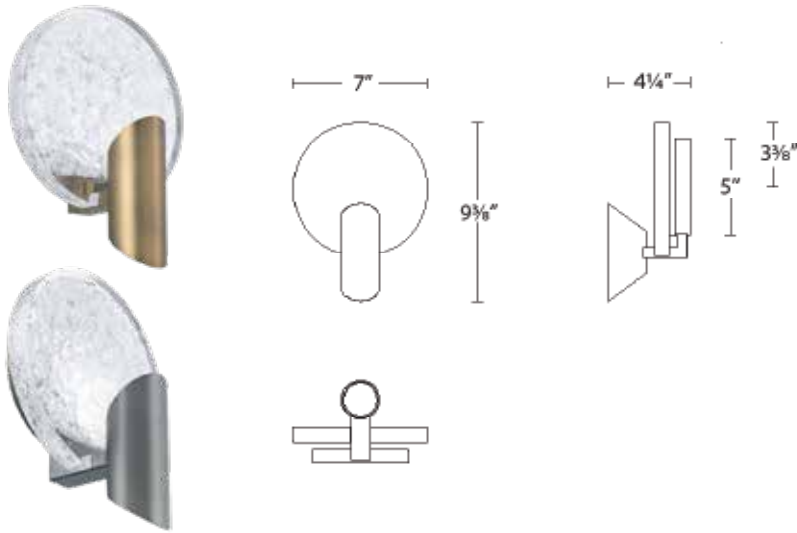

Fixture Type:

Catalog Number:

Project: _____

Location: _____

PRODUCT DESCRIPTION

Dazzling in design, Oracle features a specialized handmade technique to encase reclaimed optical crystal. The crackling sconce is indirectly illuminated from a seamless cylinder in plated aged brass. A dramatic appearance to complement luxury interiors.

FEATURES

- Retained k5 crystal
- Light is evenly diffused
- ACLED driverless technology
- Dimming: ELV
- Rated Life: 54,000 hours
- Color Temp: 3000K
- CRI: 90

SPECIFICATIONS

Construction: Aluminum body with K5 crystal insert acrylic

Light Source: High output LED

Finish: Aged Brass (AB), Antique Nickel (AN)

Standards: ETL & cETL, Damp Location listed, Title 24 Compliant

ORDER NUMBER

Model	Size	Wattage	Voltage	LED Lumens	Delivered Lumens	Finish
WS-69009	9"	11W	120V	613	438	AB Aged Brass AN Antique Nickel

Example: **WS-69009-AB**

modernforms.com
Phone (800) 526.2588
Fax (800) 526.2585

Headquarters/Eastern Distribution Center
44 Harbor Park Drive
Port Washington, NY 11050

Central Distribution Center
1600 Distribution Ct
Lithia Springs, GA 30122

Western Distribution Center
1750 Archibald Avenue
Ontario, CA 91760