

# NEREA PLUS - FV201/59D

Widespread lavatory faucet, knurled handle diamond style, with push-down pop-up drain assembly.  
 Juego de lavatorio con volante moleteado estilo diamante y desagüe "pop up".

FRANZ  
VIEGENER

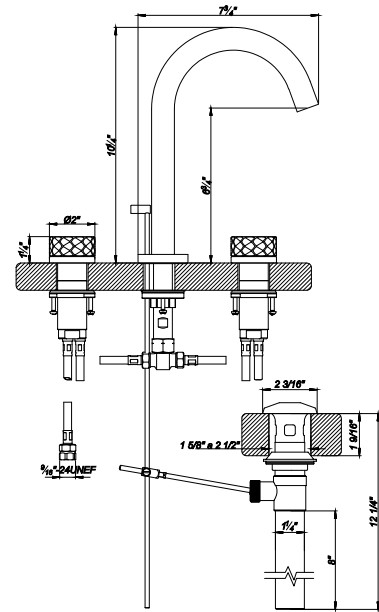





## FEATURES

### CARACTERÍSTICAS

- All brass construction.  
Producto realizado íntegramente en latón.
- Brass valve bodies.  
Cuerpos de válvulas fabricados en latón.
- Quarter-turn ceramic cartridges.  
Cartuchos cerámicos de 1/4 de giro.
- Stationary spout with recessed aerator device.  
Pico con aireador oculto.
- Flexible SS connectors with sediment screens.  
Flexibles con conectores SS y filtro de sedimento.

## COLOR / FINISHES

### COLOR / ACABADOS

- |   |   |  |
|---|---|--|
|  <b>PC</b><br>Polished Chrome. |  <b>PN</b><br>Polished Nickel. |  <b>BN</b><br>Brushed Nickel.           |
|  <b>BG</b><br>Brushed Gold.    |  <b>PG</b><br>Polished Gold.   |  <b>RG</b><br>Rose Gold.                |
|  <b>BK</b><br>Black Chrome.    |  <b>FB</b><br>Flat Black.      |  <b>UPB</b><br>Unlacked Polished Brass. |

## FLOW RATE

### CAUDAL

- Maximum flow rate 1,2 gpm (4,5 l/min).  
Caudal máximo 1,2 gpm (4,5 l/min).

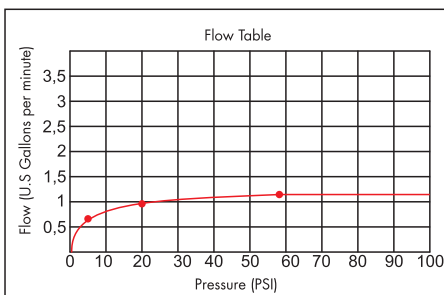

## ITEM DETAILS

### DETALLE DE PRODUCTO

## COMPLIANCE CERTIFICACIONES

