

A[~]form

Technical data sheet



Built-in basins

EB.K400

Article number: 2001000000

Design partner: sieger design



Features

Description	EB.K400
Article number	2001000000
Standard colour	White
Special surfaces	White easy-clean (XXXX XXX 400) White antibacterial (XXXX XXX 401)
Construction	without faucet hole, with overflow
Special versions	without overflow, special- or matt colour
Dimensions	15 3/4" ø
Material	Glazed steel
Net weight	4.85 lbs
Installation	for installation from above
Accessoires	Bottle trap SI.2, Bottle trap SI.3, Drain valve VT.1
Faucet information	Optimum point of impact approx. 4 3/8 – 5 7/8" from rear edge of basin.

Faucets with a vertical outlet and an aerator provide the optimum flow of water onto the surface below (angle of impact: 90°).

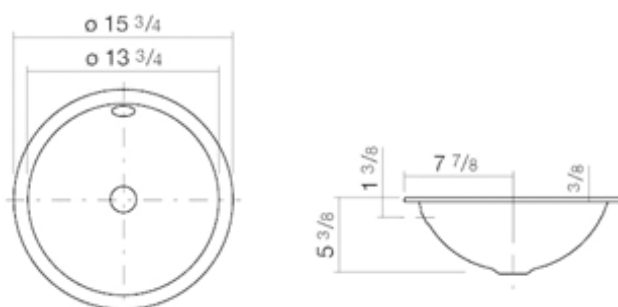

Text for invitation to tender

Built-in basin, round, 15 3/4" ø, glazed inside and outside, without faucet hole, with overflow, including installation kit and overflow set

Brand: Alape

Model: EB.K400